

# OPzV2-300(2V300Ah)



Ritar OPzV series is Valve Regulated Lead Acid battery that adopts immobilized GEL and Tubular Plate technology to offer high reliability and performance. The Battery is designed and manufactured according to DIN standards and with die-casting positive grid and patented formula of active material OPzV series exceeds DIN standard values with more than 20 years floating design life at 25 °C ,and It is the best solution for cyclic use under extreme operating conditions.



## Specification

<b>Cells Per Unit</b>	1
<b>Voltage Per Unit</b>	2
<b>Nominal Capacity</b>	300Ah@10hr-rate to 1.80V per cell @25°C
<b>Weight</b>	Approx. 24.5 Kg (Tolerance±2%)
<b>Internal Resistance</b>	Approx. 0.85 mΩ
<b>Terminal</b>	F10(M8)
<b>Max. Discharge Current</b>	1350A (5 sec)
<b>Design Life</b>	20 years (floating charge)
<b>Maximum Charging Current</b>	60.0 A
<b>Reference Capacity</b>	C24 337AH C48 375AH C72 378AH C100 385AH C120 392AH C240 399AH
<b>Float Charging Voltage</b>	2.25 V~2.30 V @ 25°C Temperature Compensation: -3mV/°C/Cell
<b>Cycle Use Voltage</b>	2.35 V~2.40 V @ 25°C Temperature Compensation: -4mV/°C/Cell
<b>Operating Temperature Range</b>	Discharge: -40°C~60°C Charge: -20°C~50°C Storage: -40°C~60°C
<b>Normal Operating Temperature Range</b>	25°C±5°C
<b>Self Discharge</b>	RITAR Valve Regulated Lead Acid (VRLA) batteries can be stored for up to 6 months at 25°C and then recharging is recommended. Monthly Self-discharge ratio is less than 2% at 25°C. Please charged batteries before using.
<b>Container Material</b>	A.B.S. UL94-HB, UL94-V0 Optional.

## Dimensions

Unit: mm

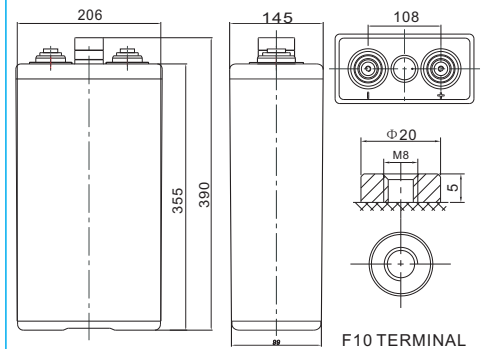

Length	145±1mm (5.71 inches)
Width	206±1mm (8.11 inches)
Height	355±1mm (14.0 inches)
Total Height	390±1mm (15.4 inches)
Torque Value	10~12 N*m

### Constant Current Discharge Characteristics : A(25°C)

F.V/ Time	30min	1h	2h	3h	4h	5h	6h	8h	10h	20h
1.90V	147.6	117.0	82.50	62.58	51.30	44.34	39.90	31.14	26.70	14.02
1.87V	165.0	129.0	88.50	66.36	54.15	46.62	42.30	32.59	27.90	14.65
1.83V	189.0	144.0	96.00	70.71	57.00	48.66	43.80	34.05	29.10	15.28
1.80V	210.0	156.0	99.60	72.75	58.14	49.80	45.00	34.92	30.00	15.75
1.75V	234.0	167.1	104.1	75.66	59.10	51.00	45.90	35.50	30.60	16.07
1.70V	258.0	172.5	107.1	77.13	60.14	51.60	46.50	35.79	30.90	16.22
1.65V	266.1	183.3	110.7	79.20	60.99	52.20	47.10	36.08	31.20	16.38
1.60V	277.5	189.6	114.9	82.50	62.70	53.10	47.70	36.38	31.50	16.54

### Constant Power Discharge Characteristics : WPC(25°C)

F.V/ Time	30min	1h	2h	3h	4h	5h	6h	8h	10h	20h
1.90V	282.5	224.6	159.5	121.2	100.4	87.30	78.90	62.27	54.42	28.57
1.87V	310.8	243.9	169.1	126.9	105.8	91.50	83.40	64.89	56.75	29.79
1.83V	348.2	265.9	180.0	133.6	111.0	95.10	86.10	67.22	58.78	30.86
1.80V	380.5	283.7	186.0	136.6	113.1	97.20	88.20	68.68	60.24	31.62
1.75V	412.8	296.4	192.1	140.8	114.6	99.60	89.70	69.55	61.11	32.08
1.70V	442.6	299.4	196.9	143.2	116.4	100.5	90.60	70.13	61.69	32.39
1.65V	450.1	312.7	202.3	146.2	117.9	101.4	91.50	70.71	61.98	32.54
1.60V	455.6	322.3	207.1	151.1	120.9	102.3	92.10	71.00	62.27	32.69

(Note) The above characteristics data are average values obtained within three charge/discharge cycle not the minimum values.

# OPzV2-300(2V300Ah)



## Discharge Characteristics Curve

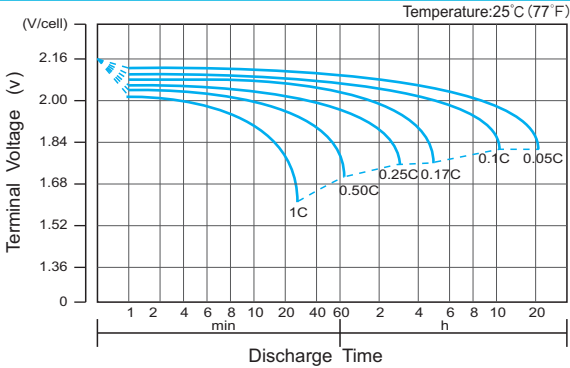

## Charge Characteristic Curve for Cycle Use(IU)

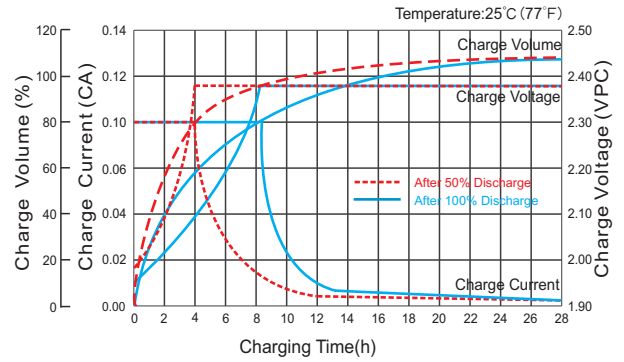

## Cycle Life in Relation to Depth of Discharge

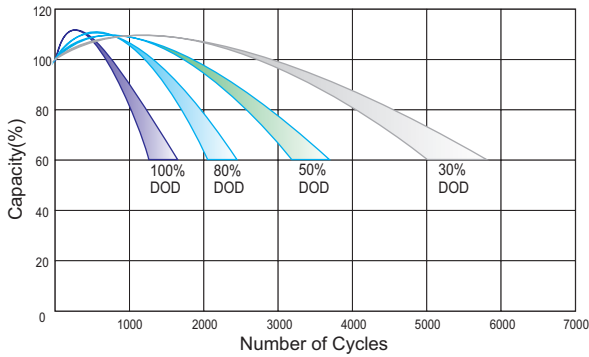

## Relationship Between Charging Voltage and Temperature

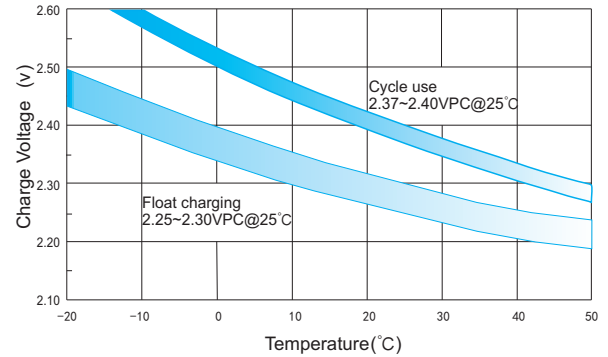

## Temperature Effects on Capacity

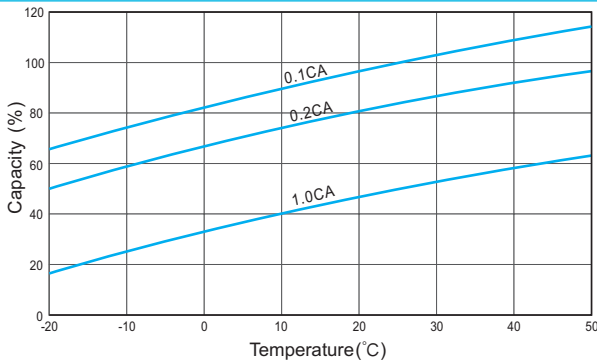

## Storage Characteristics

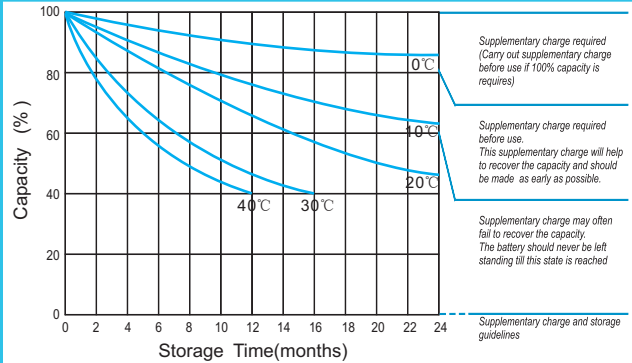

## Effect of Temperature on Long Term Life

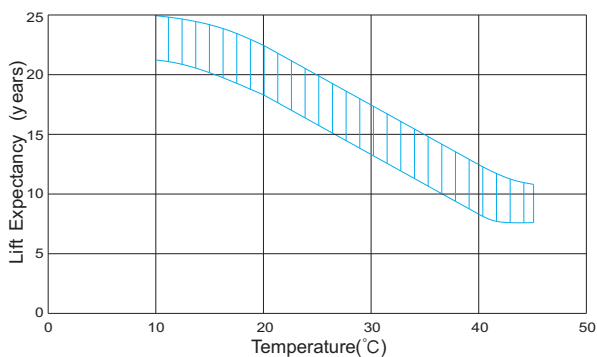

## Relationship of OCV And State of Charge(20°C)

